

IMPROVISED HOME-BUILT RECOILLESS LAUNCHERS

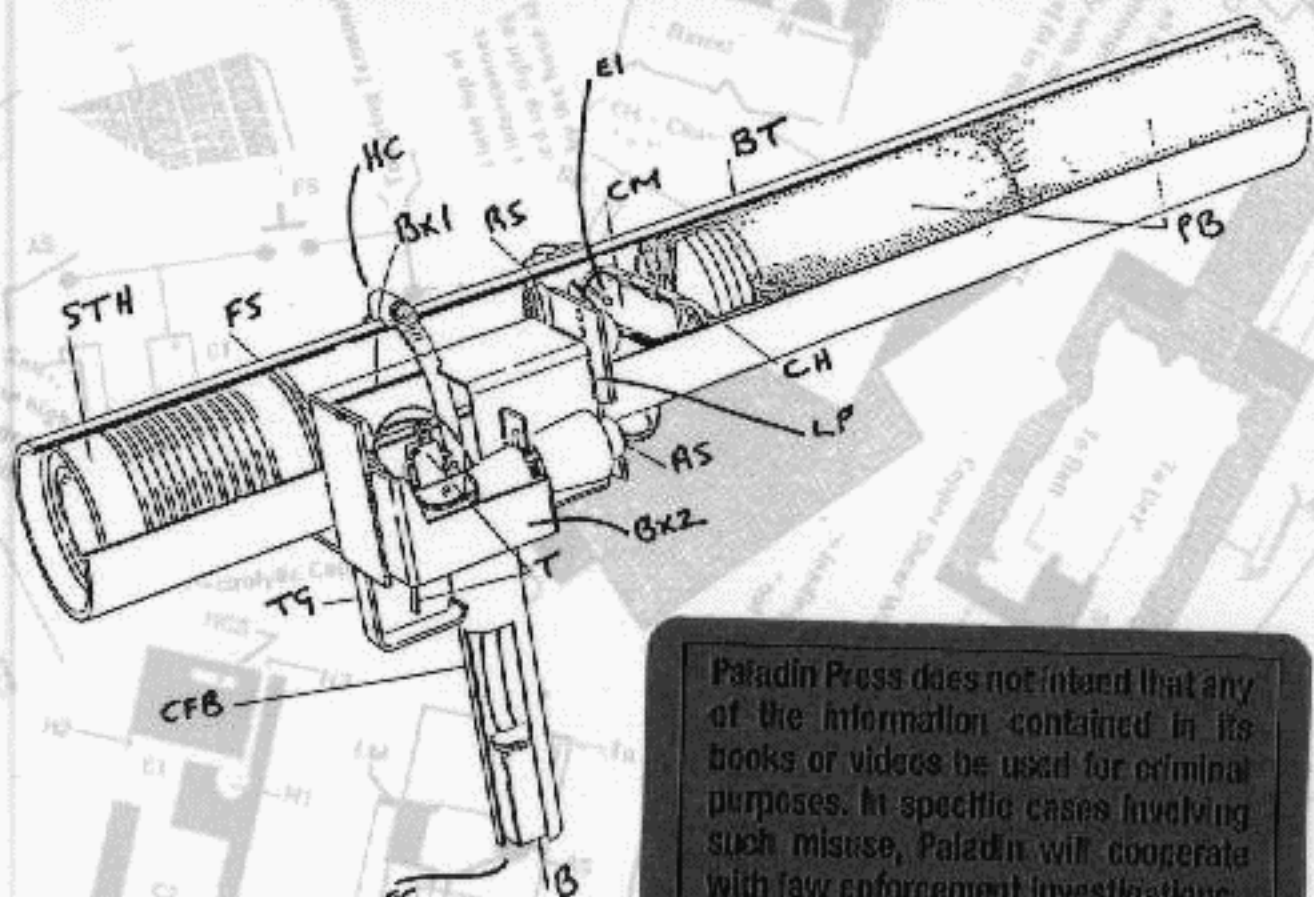

Paladin Press does not intend that any of the information contained in its books or videos be used for criminal purposes. In specific cases involving such misuse, Paladin will cooperate with law enforcement investigations.

Printed in the United States of America. All rights reserved. © 1998 by Paladin Press, Inc. ISBN 0-89586-400-0. www.paladinpress.com

F. DEMARCO

Contents

Improvised Home-Built Recoilless Launchers
by F. Demarco

Copyright © 1995 by F. Demarc
ISBN 0-87364-830-7
Printed in the United States of America

Published by Paladin Press, a division of
Paladin Enterprises, Inc., P.O. Box 1307,
Boulder, Colorado 80306, USA.
(303) 443-7250

Direct inquiries and/or orders to the above address.

PALADIN, PALADIN PRESS, and the "horse head" design
are trademarks belonging to Paladin Enterprises and
registered in United States Patent and Trademark Office.

All rights reserved. Except for use in a review, no
portion of this book may be reproduced in any form
without the express written permission of the publisher.

Neither the author nor the publisher assumes
any responsibility for the use or misuse of
information contained in this book.

Introduction	1
Chapter One Recoilless Weapons: General	3
Chapter Two Variations on a Theme	7
Chapter Three Reinforcing & Fiberglassing a PVC Barrel/Launch Tube	17
Chapter Four Charge Holder & Access Cover Options	21
Chapter Five Firing Terminals	27
Chapter Six Foregrip/Battery Holder	29

Chapter Seven

Rear Sight Assembly

31

Chapter Eight

Igniters

33

Chapter Nine

Arming & Firing Circuit

35

Chapter Ten

Charge Mix Details

37

Chapter Eleven

Charge Packets

39

Chapter Twelve

Construction of Warhead

41

Chapter Thirteen

Launcher Schematics

47

Chapter Fourteen

Countershot Assembly

49

Chapter Fifteen

Test-Firing

51

Appendix

Charge Size & Range Data

55

Warning

The procedures in this book and resulting end product are *extremely dangerous*. Whenever dealing with high explosives and improvised weaponry, special precautions must be followed in accordance with industry standards for experimentation and production. Failure to strictly follow such industry standards may result in harm to life or limb.

Before constructing any improvised weapon or making explosives of any type, care must be taken that all local, state, and federal laws are adhered to. Contact the Bureau of Alcohol, Tobacco, and Firearms (BATF) in Washington, D.C., for information on the appropriate fees and regulations.

The author, publisher, and distributors of this book disclaim any liability for any damages or injuries of any type that a reader or user of information contained within this book may cause or suffer from the use of said information. Use this material and any end product or by-product at your own risk. *This book is for academic study only.*

Introduction

Meet the world's finest (and perhaps strangest) improvised recoilless weapon system. It's less than two feet long yet capable of delivering an antiarmor or antipersonnel warhead accurately, at high speed, to a target hundreds of meters away.

This is the weapon currently taking the improvised weapons world by storm. Set to become the standard by which other launchers are measured, this system will soon be available in your local terrorist supply store. You can save big bucks, however, by purchasing these plans instead and constructing your own custom model over the weekend. "Yes," I hear you say, "but there are plenty of other plans available for weapons that are just as destructive. Why should I buy these?"

A good question, particularly appropriate in these recessionary times. We all like to be sure that we are getting the biggest bang for our buck so, by way of an answer, let me ask *you* a few questions,

- (1) Do other launchers offer less felt recoil than a .22 rifle?
- (2) Can other launchers be reloaded rapidly in the field?
- (3) Can other launchers be easily concealed beneath a jacket or coat?

Improvised Home-Built Recoilless Launchers

- (4) Do other launchers offer a "countershot" system that you can eat if you get peckish in between targets?
- (5) Do other launchers care for the environment?*

ENOUGH SAID. Put an Alice Cooper disk on the CD, pour a glass of "Milk-Plus," and start building now. You know it makes sense. See you at the hearing.

*The backblast delivers numerous cookie-crumble meals of various sizes across a broad area. Our feathered friends and small ground-dwelling creatures benefit from this, especially in times of inclement weather. Invigorated by the meal, bees will pollinate more flowers; the droppings produced by the now well-fed forest creatures will help saplings to grow; Bambi will come and forage, you can stroke him; somewhere distant an orchestra will begin playing . . . and all because you purchased this book. Without you everything will die and rot. Buy it, you miserable bastard.

Chapter One

RECOILLESS WEAPONS: GENERAL

The term "recoilless" refers to a weapon which, when fired, remains completely still and does not kick back. In a normal (recoiling) gun, complex and/or large and heavy recoil mechanisms must be incorporated to absorb the shock generated by the burning propellant gases that kick the warhead, shell, or round out of the barrel and toward the target. The larger the caliber of the weapon, the heavier these mechanisms become until a point is reached where substantial mountings or carriages are needed to support them. The recoilless gun does away with the need for these absorption mechanisms and allows even very large caliber weapons to be fired from a mount as light as a man's shoulder.

In its simplest form, the recoilless effect can be achieved by firing two equal weights (one being the forward firing projectile, the other a rearward firing countershot) at equal velocities. Credit for the development of the first recoilless gun goes to one Commander Davis of the U.S. Navy, who designed his system during World War I. The weapon assembly comprised two gun barrels pointing in opposite directions, one of which contained a projectile, the other an equal weight of lead shot and grease. A central chamber facilitated loading. In operation, the countershot was dissipated in the air behind the weapon. Various types

of Davis guns were, apparently, fitted to certain British naval aircraft with a view to engaging enemy submarines, but it is unlikely that they were ever actually used in anger.

As weapons development evolved, it was postulated that if two equal weights (projectile and countershot) moving away from each other at the same speed provide a recoilless effect, then a countershot *weighing half as much as the projectile but traveling at twice the speed* should achieve the same effect. This proved to be the case. It was discovered that if the product of the countershots mass multiplied by its velocity remained the same, the weapon would *always* be recoilless. Further, the countershot need not be an actual "weight" at all, and most current recoilless gun systems exploit this fact by utilizing a stream of gas as the countering force. The gas, although of course very light, is made to move at an extremely high velocity using a venturi assembly. Thus, the requirements of the above equation are fulfilled.

A World War II German system (which is still employed in some modern recoilless weapons) uses a cartridge case with a plastic (rather than solid metal) base. The plastic base has precise pressure-resistance characteristics and when the weapon is fired, it remains whole just long enough for the projectile to begin moving. The disk then ruptures, allowing gas to vent through a venturi and nozzle assembly. The venturi increases the velocity of the gas flow so that when multiplied by its mass, the product is equal to the velocity of the projectile multiplied by its mass, and the weapon remains recoilless.

Another technique used in various American recoilless rifles incorporates a cartridge case with a conventional (solid) base but with a double-walled body. This takes the form of a thin metal or plastic inner liner and a perforated metal outer case. Upon firing, the inner liner ruptures, and the gas flows out through the perforations into an annular channel in the chamber of the launcher to a venturi assembly.

The following illustrations show weapons from both ends of the recoilless gun technology spectrum.

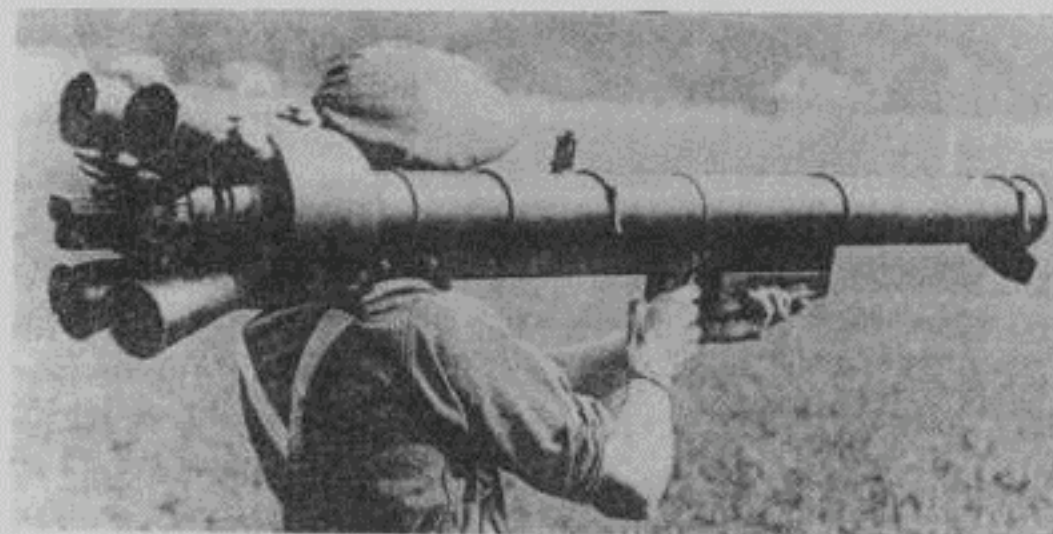

Figure 1: WWII British 3.45-inch Recoilless Gun.
Note the multiple venturi assemblies that give this weapon a rocket-like appearance.

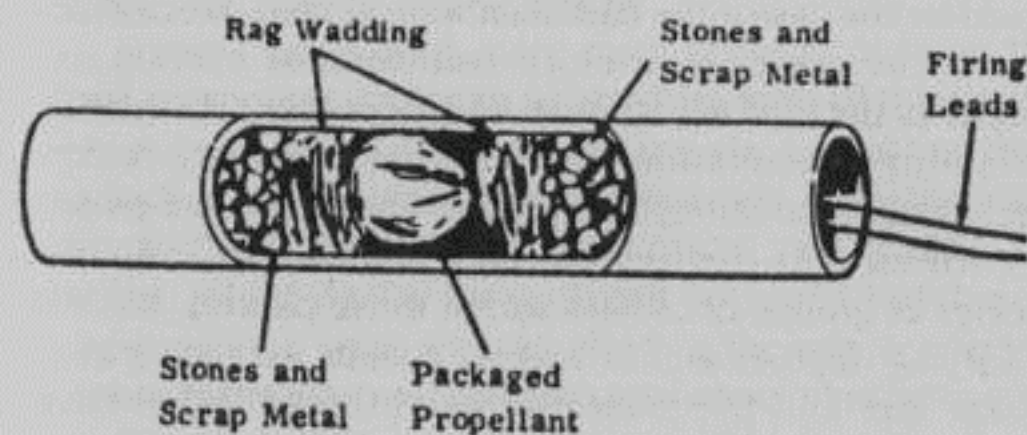

Figure 2: U.S. Special Forces Improvised Recoilless Launcher.
This dual-directional device appears in several Vietnam War era service publications and comprises a 4-foot long, 2- to 4-inch diameter iron water pipe. A 1/2-pound black powder charge is bagged with an electrical igniter and placed centrally in the pipe. Rag wadding and equal weights of stones and/or scrap metal are packed on either side of the charge, as shown.

THE DOWNSIDE?

If anything negative can be said about modern commercial recoilless weapons, it is that (1) considerably more propellant is needed than in a comparable recoiling gun because, in the recoilless system, some 4/5 of the charge powder is vented through the venturi; and (2) this venting gas and flame is highly visible to an enemy and dangerous to persons in the immediate area.

DECEPTIVELY SIMPLE

It is worth noting that the improvised recoilless weapon detailed in the following pages prevails over a venturi-based system because the backblast is contained and smothered to a large degree by the countershot material used. Its signature is therefore small, and the weapon can be fired from inside a building with far greater safety than would be the case if the backblast were vented directly to air.

The cookie-and-cloth countershot system used herein is deceptively simple and possesses an intrinsic variability of operation that requires extremely complex mechanical assemblies to replicate. The entire two-packets-of-cookies-and-cloths assembly, and/or the individual cookies or groups of cookies within those packets, will react in varying degrees and at various speeds according to the charge size and the projectile weight used (other things being equal). Also, there is a "firing envelope" outside the parameters of which the weapon will be ineffective and/or unsafe.

Chapter Two

VARIATIONS ON A THEME

Figure 3 shows a version of the "cookie" launcher that is currently used by a well-known terrorist organization. For legal reasons, I cannot name the organization here. I do, however, hurriedly acknowledge the ingenuity of the originator, whoever he or she may be.

Note that as with many such terrorist devices, the original component parts are selected because of their ready availability and non-trail-generating status, rather than because they are the most sophisticated, tidy, or aesthetically pleasing. Thus, the bulb-holder arming switch (AS), for example, might easily be replaced with any number of alternative switch types without affecting the safe or effective operation of the weapon. This also applies to other parts such as the foregrip/battery holder, sight assembly, and so on.

With this in mind, I have included plans for the construction of a variant developed by Anthony Lewis, author of *Bazooka*, from the model shown in the illustration below. Between the original design and the Lewis variant, countless possibilities exist.

It is worth mentioning that, like most people seeing the design for the first time, Lewis displayed some skepticism about the effectiveness of the countershot system. Nevertheless, he went along with the project and

Figure 3: Recoilless "Cookie" Launcher.

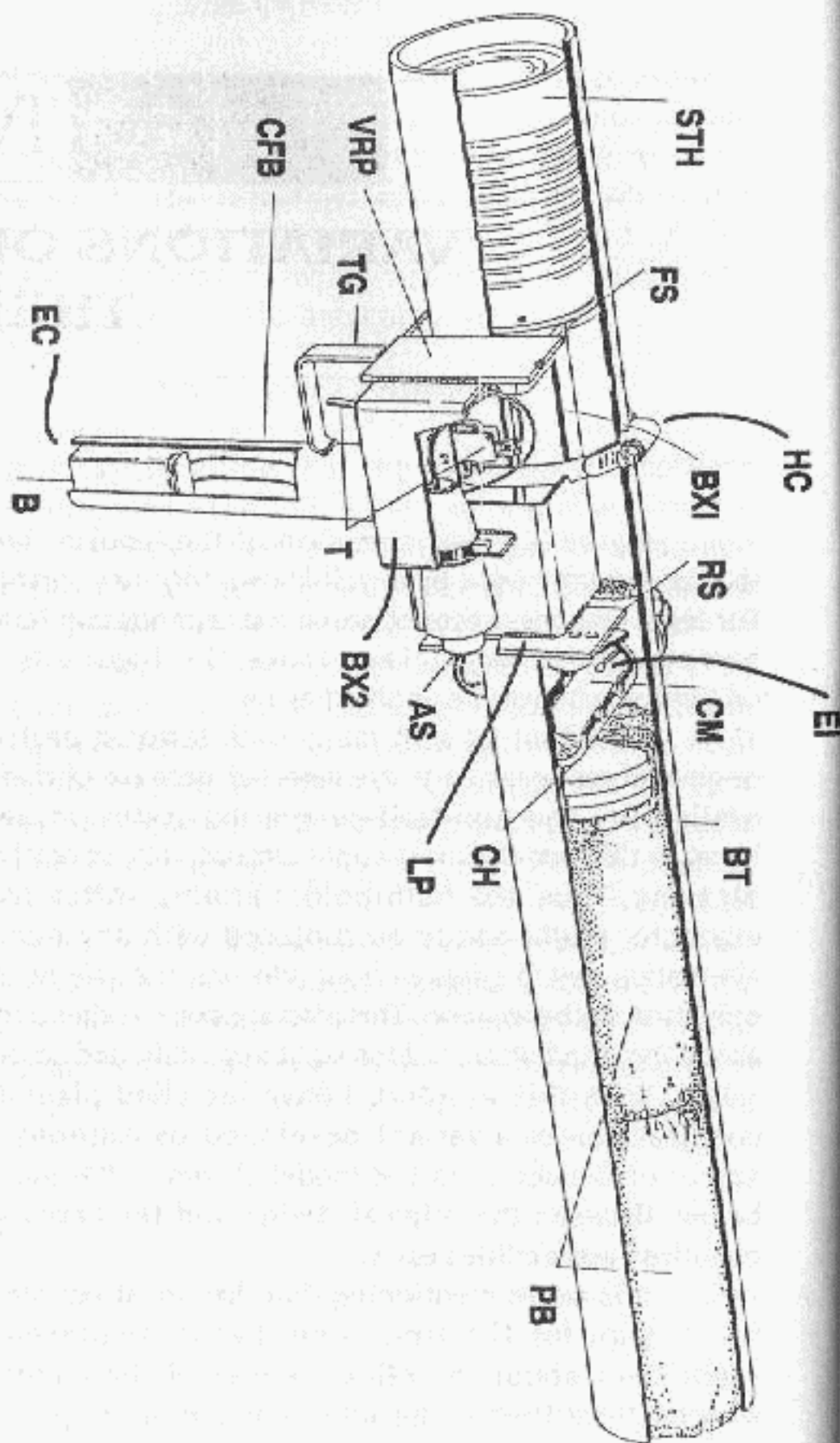

Figure 3 Legend and Materials

- BT = Barrel/Launch Tube: 1/8- to 1/4-inch thick steel or Dural pipe with 2 1/2-inch internal diameter, and 22- to 30-inch length. The centrally positioned hole in the wall of BT is of a diameter that facilitates the installation of charge holder (CH).
- BX1 = Box Assembly: Plastic or metal. Cut away and modified as shown and secured to BT with hose clip (HC).
- BX2 = Box Assembly: Plastic or metal. Half the length of BX1. Cut away and modified as shown.
- AS = Arming Switch: Switched table lamp bulb holder and holder adapter assembly mounted in BX2 as shown. (See Figure 4 for circuit connection diagram.)
- HC = Hose Clip: (Also known as "jubilee" clips in some quarters.) 3-inch diameter, 1/4-inch width (or as available). Passes through BX1 and around BT.
- FS = Front Sight: Notches filed in vertical rectangular plate (VRP) forming "blade." (See Figures 5 and 5A for details.)
- T = Trigger: Long-arm microswitch. (See Figure 4 for circuit connection diagram.)
- TG = Trigger Guard: Metal or plastic L-shaped piece.
- VRP = Vertical Rectangular Plate: Metal or plastic.
- LP = Square Plate: Metal or plastic. Cut into L-shape as shown. Attached to BX1.
- RS = Rear Sight: Peephole(s) pierced in LP in line with FS. Specific distances between holes for different ranges are determined during initial test-firings. (See Figures 5 and 5A.)
- CH = Charge Holder: (Also acts as a warhead standoff spacer keeping the distance between the warhead base and countershot more-or-less constant during loading.) Numerous design possibilities. For example, a 3/4- to 1-inch diameter metal cylinder with screw-on, screw-in, or similarly secure top, its body drilled circumferentially, as shown, and being 1/2- to 3/4-inch longer than the diameter of the barrel.
- CM = Charge Mixture: Various possibilities. For example, a 1- to 4-gram charge of potassium perchlorate and aluminum powder.
- EI = Electrical Igniter: Commercial or improvised type.
- CFB = Cylindrical Foregrip/Battery Holder: PVC or metal. 6-inch length with 1 1/2- to 2-inch diameter, secured to base of BX1. Contains the battery.
- B = Battery: (See Figure 4 for connection details.)
- EC = End Cap: Plastic or rubber. Friction fit on CFB, or use gaffier tape.
- PB = Packets of Cookies: Two packets wrapped in "J" cloths, a bonded fiber product (rather than straight paper or cloth) that is, typically, a mixture of 75 percent viscose and 25 percent polyester. They are marketed under a variety of brand names. Typical cookie packet dimensions are approximately 4 inches long by 2 3/8 inches wide.
- STH = Soup Can Warhead: (See Figure 6 for construction details.)

even volunteered to undertake the initial test-firings. To say he was impressed with the results is an understatement. He was positively inspired. Watch out for Lewis' next book. I promise you, you *don't* want to miss it!

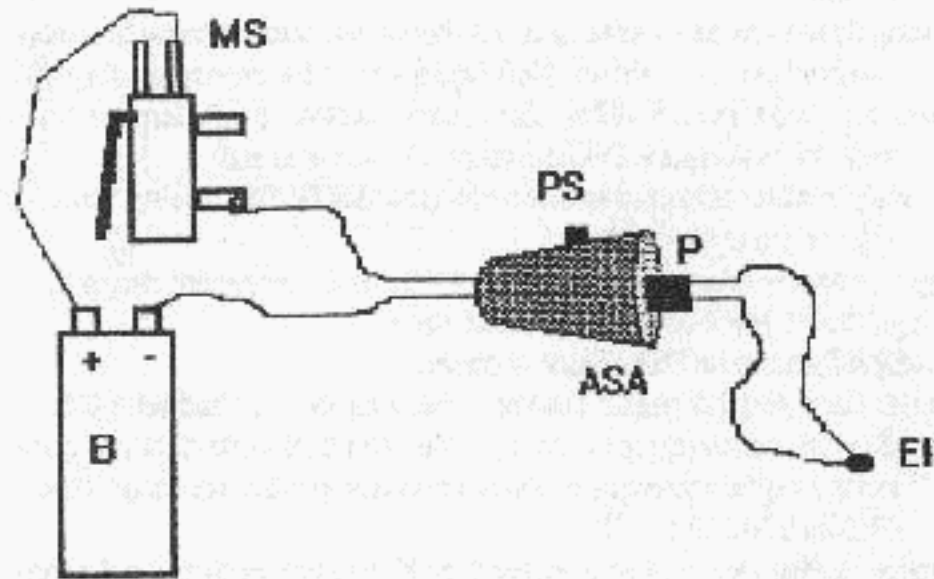

Figure 4: Arming and Firing Circuit Connection Details.

B = Battery

MS = Microswitch

ASA = Arming Switch Assembly

EI = Electrical Igniter

P = Plug (plug into ASA and depress PS to arm)

PS = Push Switch

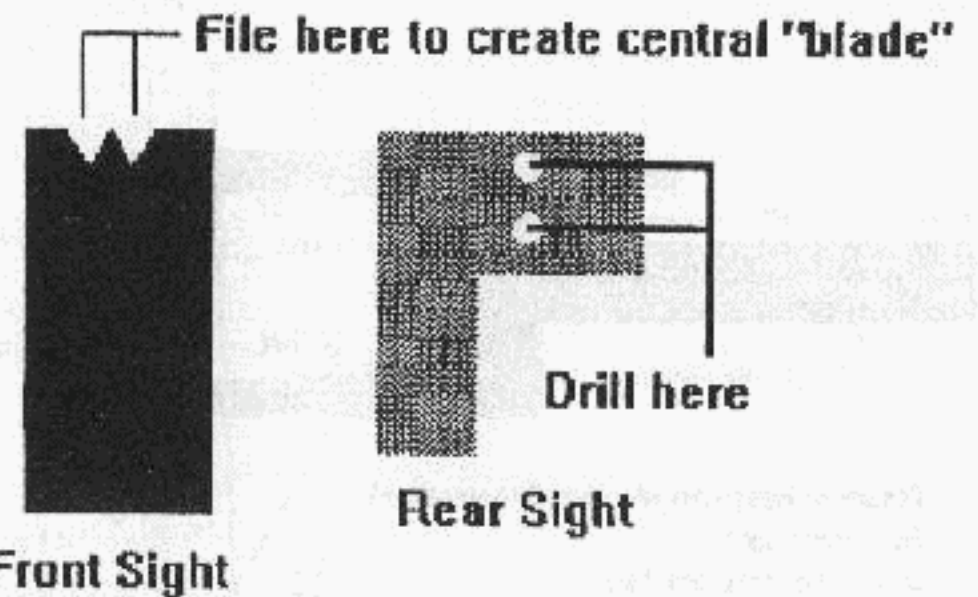

Figure 5: Front and Rear Sight Detail.

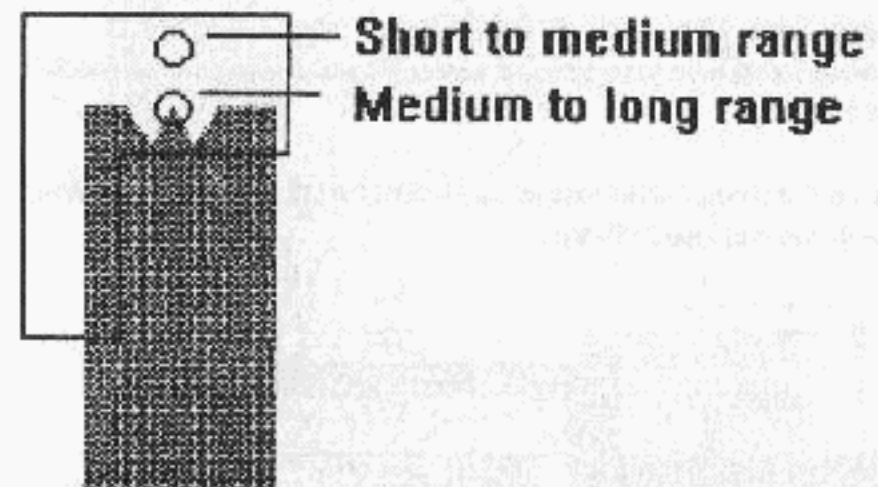

Figure 5A: Front and Rear Sights Superimposed.

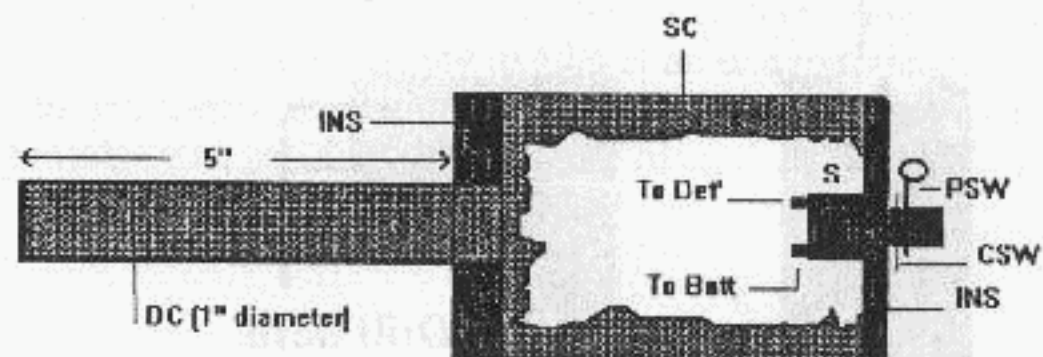

Figure 6: Soup Can Warhead Schematic #1.

- SC = Soup Can*
- INS = Insert (wooden disk)
- S = Switch (press-to-make type)
- DC = Dowel Counterbalance
- DET = Detonator
- BATT = Battery
- CSW = Copper Shear Wire (resists all but high-impact pressures against S)
- PSW = Positive Safety Wire (a far stronger wire or pin which is removed immediately before loading)

*SC should have a sliding but not excessively loose fit in the launcher barrel. Wrap SC body with masking tape if required.

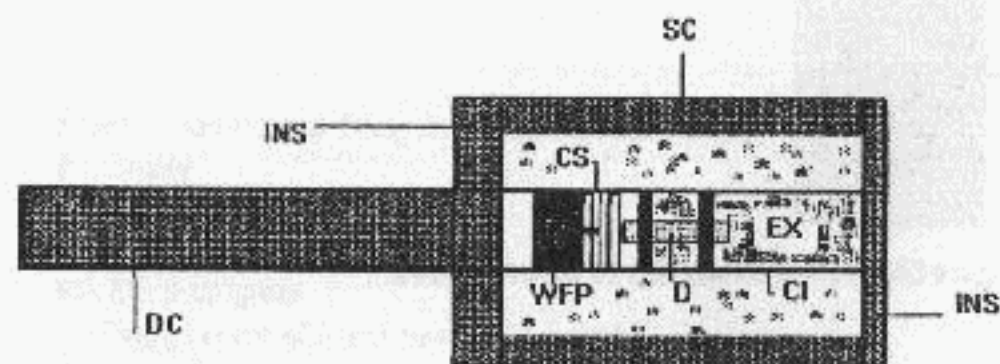

Figure 7: Soup Can Warhead Schematic #2.

- SC = Soup Can
- INS = Insert (wooden disk)
- DC = Dowel Counterbalance
- WFP = Weighted Firing Pin
- CS = Creep Spring (resists forward movement of WFP under all but severe, sudden frontal impact conditions)
- D = Detonator (stab-sensitive primer installed)
- CI = Cylindrical Insert
- EX = Explosive Material

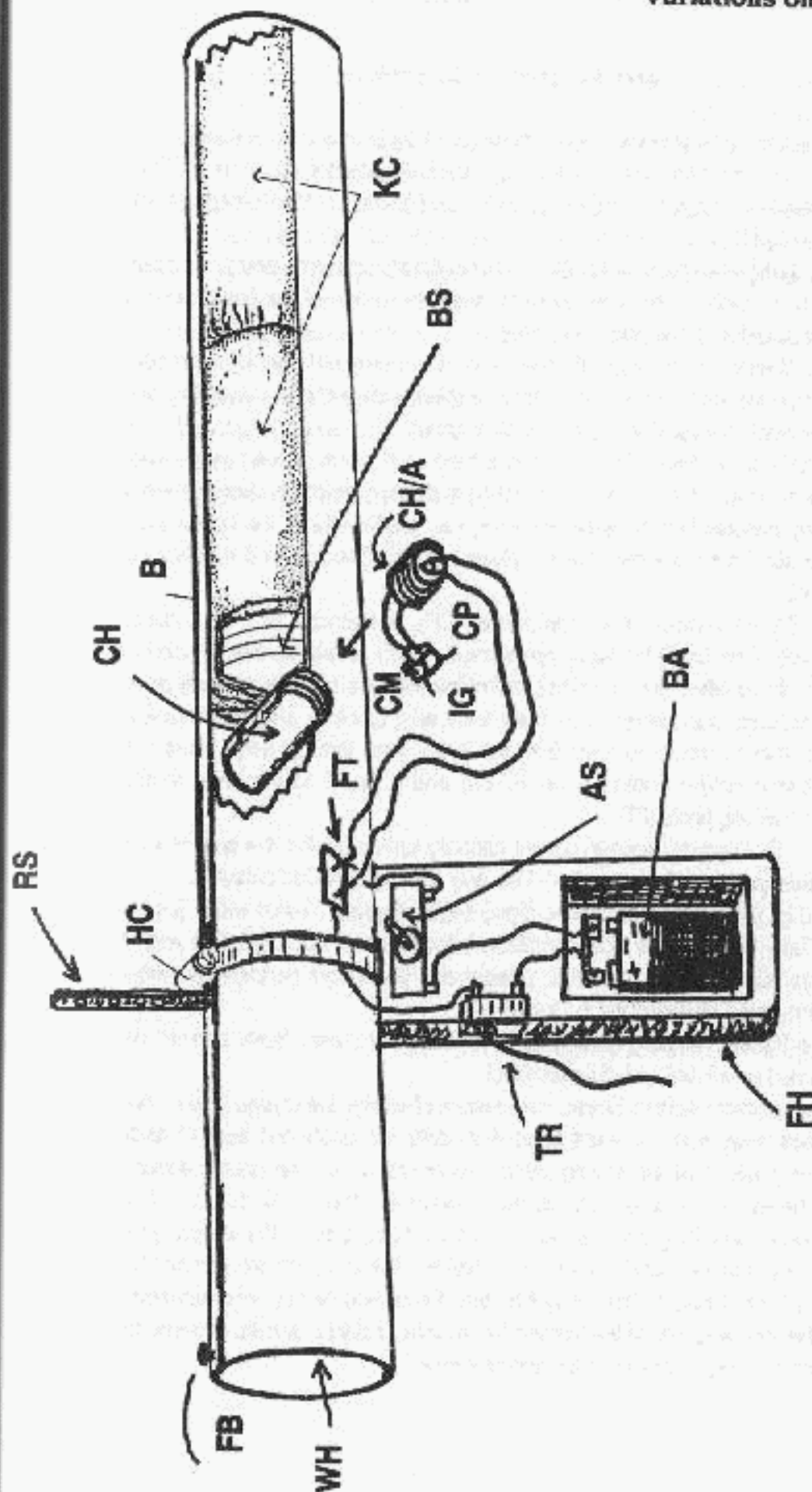

Figure 8: Recoilless "Cookie" Launcher, Lewis Variant (not to scale). (See legend on following pages.)

Figure 8 Legend and Materials

- B** = Barrel/Launch Tube: One 24- to 34-inch length of 2 1/2-inch internal diameter, 1/8- to 1/4-inch thick, steel tubing or 2 1/2-inch internal diameter PVC/ABS drainpipe/conduit with PVC sleeving and fiberglass reinforcement. (See Chapter 3.)
- TR** = Trigger: Long-arm microswitch. One terminal (input) connects directly to positive side of battery, the other (output) connects to one of the firing terminals. Insulated wiring is used throughout.
- AS** = Arming Switch: Small single-throw switch. Input terminal connects directly to negative side of battery; output terminal connects to remaining firing terminal. Insulated wiring is used throughout.
- FH** = Foregrip/Battery Holder: Used here is a hardwood piece with a cutout foregrip measuring 5 1/2 inches x 2 1/4 inches x 3/4 inch, which contains the battery. Any suitable improvisation will work, i.e., plastic tubing, the hollow plastic handle from a packing tape roll dispenser, etc. Secured to B with hose clip (HC).
- IG** = Igniter: Shown installed in charge packet (CP), surrounded by charge mixture (CM). Can be Estes type, pyrotechnic match (available from Phoenix or theatrical effect supply stores), or improvised type such as cutaway auto or flashlight bulb, which is partially filled with black or smokeless powder. Insulated connecting wires from the igniter pass through small holes in the charge holder access cover (CH/A) and connect to the firing terminal connecting posts (FT).
- BA** = Battery: Of adequate voltage/current capacity to reliably fire the type of igniter used (or use with a capacitor). Use only alkaline or NiCad batteries.
- HC** = Hose Clip: (Also known as Jubilee clips.) 4-inch diameter, 1-inch width. (Use two if only 1/2-inch wide type is available.) Secures both rear sight (RS) and FH.
- CM** = Charge Mixture: Fine aluminum powder and potassium perchlorate mixture. (Prepared as described in Chapter 10.)
- CP** = Charge Packet: Masking (paper) tape "envelope" or plastic "party popper" body (used or unused and disassembled).
- CH/A** = Charge Holder/Access Cover: For reasons of safety, the charge holder should face away from the firer's head. For additional safety and ease of control, the position of the arming switch (on or off) should be readily apparent. Therefore, the switch should face toward the firer. Note that the charge holder and firing terminals are on the left-hand side of the weapon in this illustration, i.e., configured for a left-handed firer using the weapon on his (or her) left shoulder. This being the case, the arming switch, which appears on the left-hand side of the foregrip for reasons of clarity, should, in reality for a left-hander, be moved to the opposite side.

- FT** = Firing Terminal Connecting Posts: Two screw type or spring-loaded connecting posts. FT is attached to B with insulating material if B is metallic. Epoxy resin will act as both insulator (once dry) and attachment material. Roughen the area before applying epoxy.
- FB** = Foresight Bead: Small screw. The screw must not penetrate the inner wall of the launcher tube. An adjustable front sight can be made by affixing a small, deep nut (or two slimmer nuts stacked) to the launcher using epoxy and screwing the screw in or out, as required.
- RS** = Rear Sight: Various options are possible. Used here is a simple sliding peephole type mounted on an L-shaped piece of metal having a 3-inch long vertical piece. Attach to B with HC.
- WH** = Warhead: Wooden type.
- BS** = Biscuits (cookies).
- KC** = Kitchen Cloths/Household Cloths (J cloths).

Chapter Three

REINFORCING & FIBERGLASSING A PVC BARREL/LAUNCH TUBE

This section is only applicable if you are using a PVC launcher tube. If a PVC barrel/launch tube is to be used, it should be reinforced with two additional lengths of PVC pipe sleeving and three layers of fiberglass matting. One of these layers will cover the entire launcher tube, the other two will reinforce the breach/charge holder area.

REINFORCING

Step one in the reinforcement process is to obtain two additional lengths of PVC pipe to be used as reinforcing sleeves. One should be the same length as the launcher barrel itself, the other approximately 6 inches long. Ideally, the longer of the two sleeves should have a diameter that allows a friction fit over the barrel and the other a diameter that allows a friction fit over the first sleeve. If tubing of a suitable diameter cannot be obtained, use two lengths of tube of the same diameter as the barrel and cut each of them along their length.

Next, roughen the outside of the barrel and the inside and outside of the sleeves with sandpaper and coat the outside of the barrel with a layer of PVC cement (available from hardware stores). Slide the longer of the

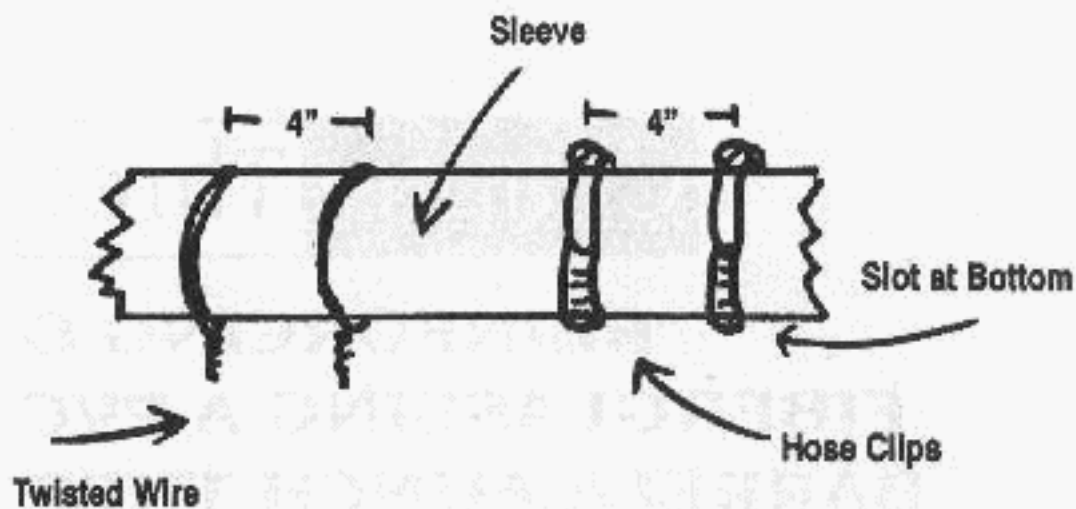

Figure 9: Securing the Reinforcing Sleeves While the Adhesive Dries.

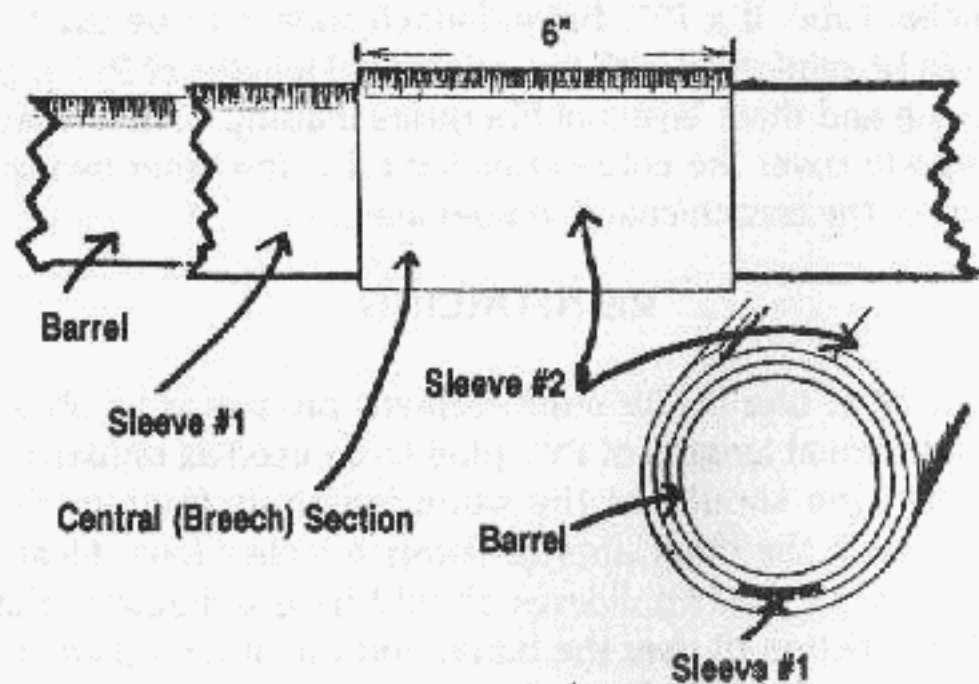

Figure 9A: Relative Positions of Reinforcing Sleeves.

tubes over the barrel and adjust until the barrel and sleeve ends are flush. Secure the assembly using several tightly wound, evenly spaced wraps of stiff wire or hose clips. At a pinch, gaffer or masking (reinforced paper) tape can be used, the idea being to force out excess air and adhesive and to hold the assembly together securely while it dries. When dry, remove the wire or hose clips and repeat the process using the shorter sleeve. Position this piece centrally and so the slot is exactly opposite (180 degrees from) the slot of the first reinforcing tube. Once the PVC cement has dried, remove the wires or hose clips and continue with the rest of the assembly instructions as outlined in the following chapters.

FIBERGLASSING

Return to this section for details on fiberglassing when *all* other components have been attached. Full instructions are supplied with fiberglassing kits, but the basic principles to remember are:

- (1) Attach all fittings to the tube *before* fiberglassing.
- (2) Protect the inside of the barrel, moving parts, and electrical connection points from resin.
- (3) Sandpaper the outside of the PVC pipe before commencing.
- (4) Determine the size needed and cut the fiberglass matting accordingly before commencing.

To fiberglass the tube assembly, first apply resin to the central reinforcing sleeve section and work the matting in well with a paintbrush, ensuring that the matting is well moistened and close-fitting to the tube and around the charge holder shoulders. When this has dried, continue with the rest of the tube, doing one section at a time from one end of the tube to the other and including again the central area. When dry, apply a final layer around the central breach area.

Chapter Four

CHARGE HOLDER & ACCESS COVER OPTIONS

To facilitate rapid reloading and consistent launch results (the latter by virtue of the fact that when the technique described here is employed, the distance between the charge, warhead, and countershot will, other things being equal, remain constant), pre-prepared, packeted charge and igniter assemblies are loaded into a central charge holder (CH) from the outer wall of the tube through a secure, positive-locking (or screw-on) metal access cover. Two insulated connecting wires from the igniter pass through this cover and attach to the firing terminals (FT).

The assembly may be improvised in many ways using a variety of parts. But note that in all designs involving a screw-in type of access cover, you must gently twist the igniter wires (once they are fed through the cover) in the opposite direction to that required to secure the cover, i.e., if the cover screws in or on clockwise, twist the wires counterclockwise. This ensures that when the cover is fitted, the wires will untwist, thus removing the risk that the twisting action caused by fitting the cover will pull the wires from the igniter. Insert the igniter/charge pack into the charge holder after the wires have been fed through the cover and twisted accordingly.

Charge holder assemblies may be made from gas

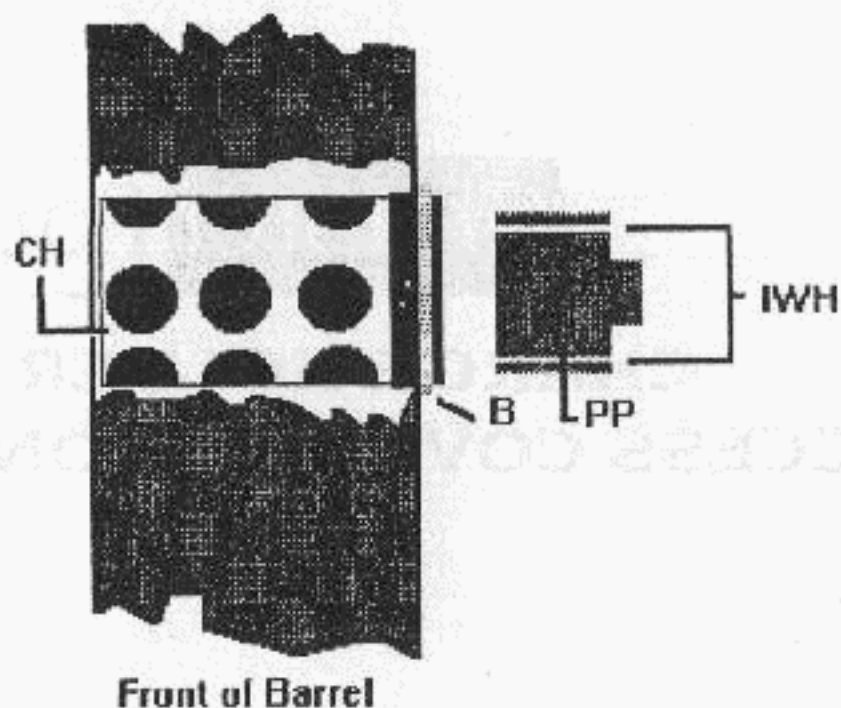

Figure 10
 B = Braze or Weld
 CH = Charge Holder* (threaded internally)
 PP = Pipe Plug (threaded externally)
 IWH = Igniter Wire Holes
 *CH drilled as indicated with 1/4-inch holes

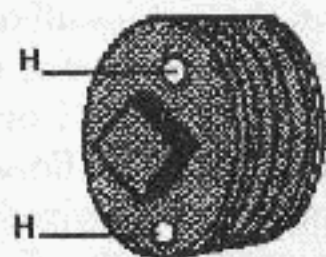

Figure 10A: Pipe Plug.
 H = Hole (1/8-inch diameter)

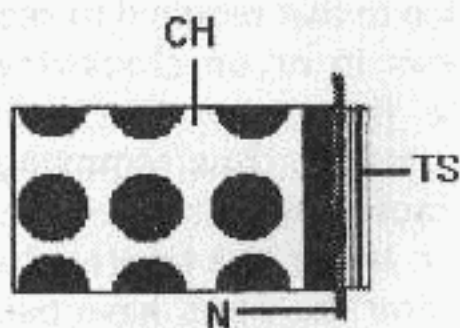

Figure 11
 CH = Charge Holder
 N = Nut
 TS = Threaded Section (internally and externally)

pipe or water pipe (threaded internally at one end) and are used in conjunction with a pipe plug fitment (drilled as indicated) for a cover. Installation of the holder in the barrel is achieved by brazing or welding around the point where it exits the barrel wall or by threading both the outside of the holder and the walls of the hole and screwing the assembly into it. In the case of PVC barrels, all charge housing assemblies are to be installed prior to the application of fiberglassing material.

An alternative that can be used with metal or PVC barrel tubes is to tap a section of the outside of the pipe (the same end that is already threaded internally to take the plug) and attach a nut.

Next, place the assembly in position inside the tube with the threaded end protruding through the hole and affix a second nut on the outside, thereby locking the assembly in place. A similar effect can be achieved if the outer diameter of the nonthreaded section (the section that will be *inside* the tube) is 1/4-inch or so greater than that of the threaded section. Apply liberal amounts of epoxy adhesive to all surfaces and "Loctite" to all threads before assembling.

The technique I recommend for use with a PVC barrel is to weld or braze the charge holder to the inside face of a section of metal plate that has been curved to fit the contours of the launcher tube (by hammering it over a metal pipe of a similar diameter). Drill a hole in the launcher body and, after coating the inside face of the curved plate with epoxy, install the assembly. Attach two hose clips (one on either side of the holder) to lock the assembly in place prior to the application of fiberglass reinforcement material. This technique also provides additional reinforcement for the breach area.

An untapped holder can be used, the outermost end of which is cut as shown below to create a press-and-turn-to-lock effect when used with the accompanying cover. A variation is to have the lugs on the cover and the cutouts on the end of the charge holder.

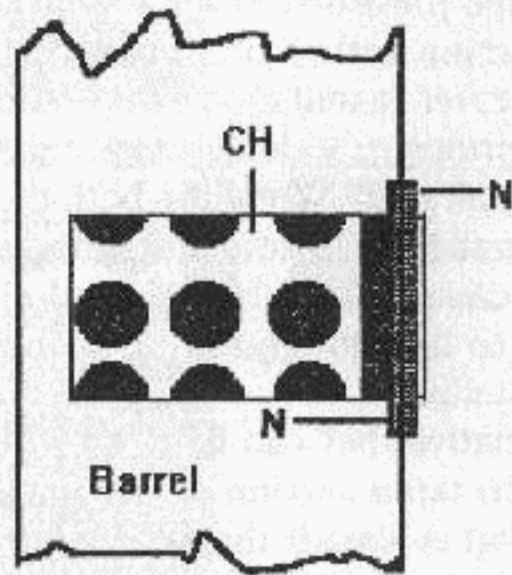

Figure 12
CH = Charge Holder

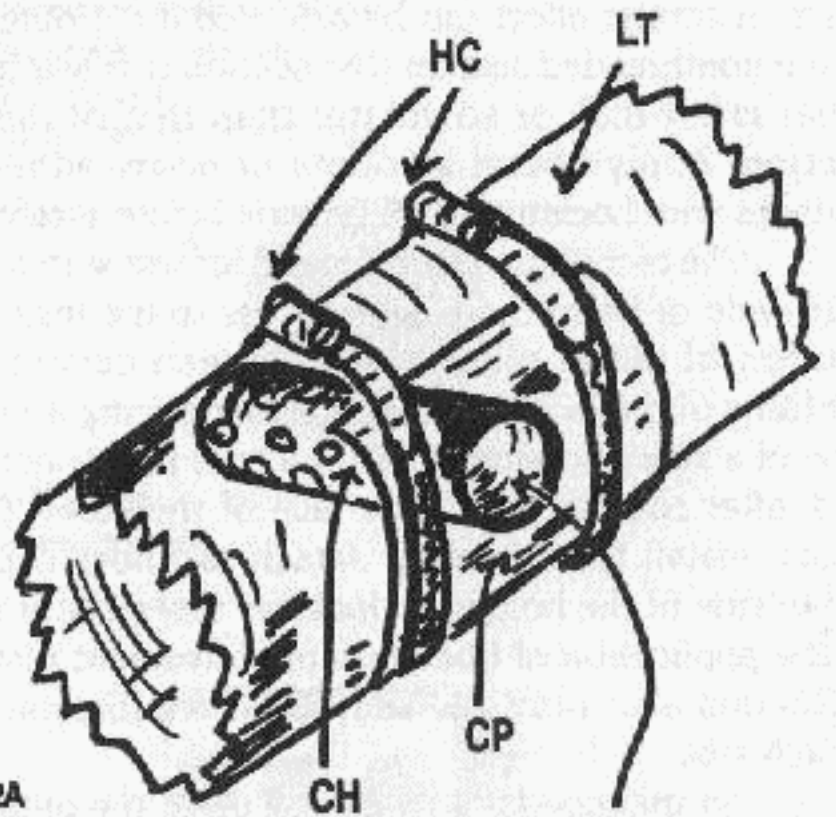

Figure 12A
LT = Launcher Tube
HC = Hose Clip
CH = Charge Holder (inside LT)*
CP = Curved Plate
*CH welded to inside face of CP

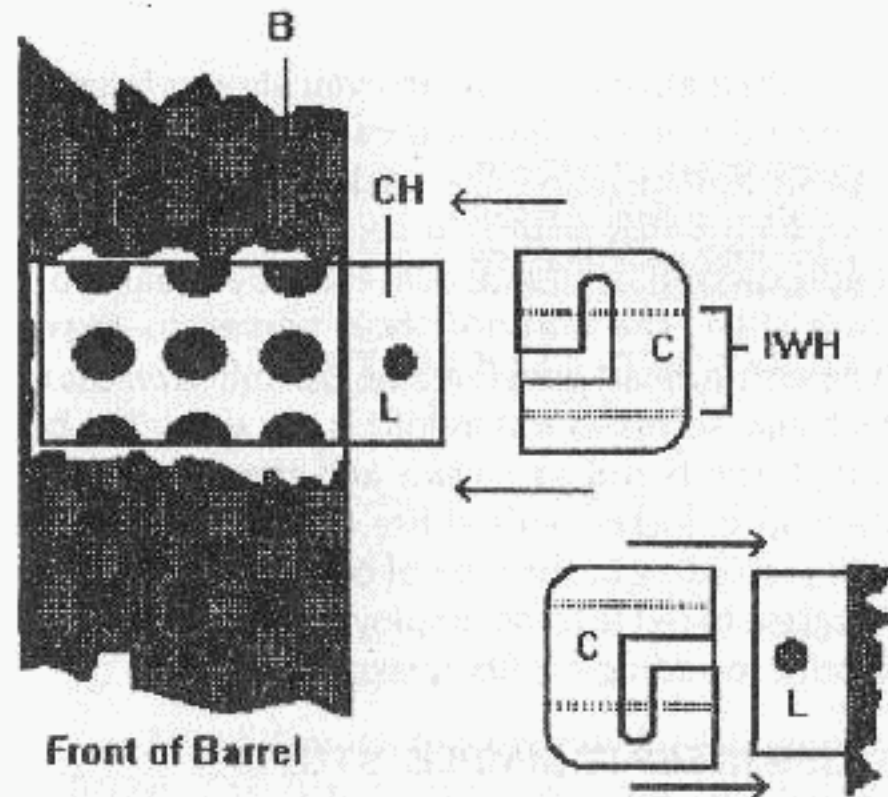

Figure 13
B = Barrel
CH = Charge Holder (drilled as indicated with 1/4-inch holes)
L = Lug (same on opposite side of CH)
C = Cap (push on and turn to secure)
IWH = Igniter Wire Holes

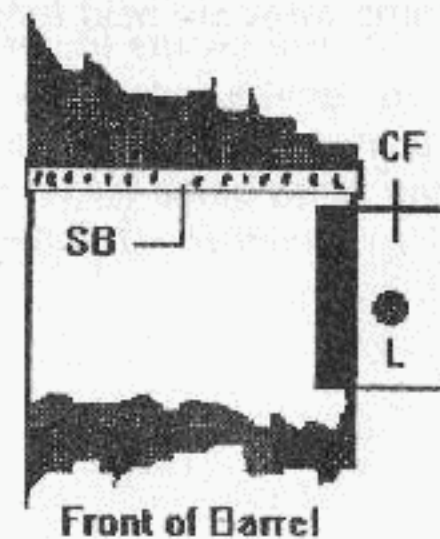

Figure 14: Standoff Bolt.
SB = Standoff Bolt
CF = Cover Fastening
L = Lug

A final alternative is to use an even shorter length of pipe to create little more than a means of fastening the access cover. In this instance, the packeted charge simply rests in the barrel (rather than in a separate housing), and the warhead standoff effect is achieved by means of a standoff bolt (SB). The standoff bolt serves to ensure identical charge/warhead spacing when a full-size charge holder (which also serves as a standoff) is not used. The bolt passes through the barrel as shown and the securing nut (after tightening) is locked with either epoxy adhesive or a braze or weld (according to the type of barrel material used). If a PVC/fiberglass barrel is to be employed, the standoff bolt is installed prior to adding the fibreglassing material.

KISS (KEEP IT SIMPLE, STUPID!)

Note that in its crudest form, the launcher need not employ a charge holder or access assembly at all. Instead, the packeted charge/igniter assembly is simply positioned centrally in the barrel, with the igniter wires leading out through the rear of the barrel, and the standoff bolt technique described above is used. If using this approach, ensure that the igniter wires are held firmly when loading the countershot.

Chapter Five

FIRING TERMINALS

Attach the igniter wires to the firing terminals prior to firing. The firing terminals may be mounted on the outside of the barrel/launch tube or on/in the foregrip.

Use simple electrical binding posts, taking the form of metal pins mounted on a paxolin base or spring-loaded terminals of the type used in loudspeaker hookups, attached with epoxy resin adhesive. The ends of the insulated firing terminal wires can, instead, be terminated in alligator clips. If installation is to be made on a metal barrel/launch tube, care must be taken to ensure that the rear connections of the terminals are not shorted out. To this end, apply an insulating layer of epoxy adhesive, fiberglass, plastic tape, sticky pad material, or some other improvisation to the barrel before attaching the terminals.

Chapter Six

FOREGRIP/BATTERY HOLDER

The option used here is a simple wooden grip cut away and drilled internally, as shown on the next page, to accommodate the battery, arming switch, and interconnecting wires. The dimensions of the foregrip used here are 5 1/2 inches x 2 1/4 inches x 3/4 inch.

Attach the foregrip to the barrel with a 4-inch diameter hose clip, wrapping the hose clip around the barrel and through the HCS. This same clip can be used to attach the rear sight assembly. An alternative foregrip/battery holder can be improvised from the hollow plastic handle and base plate parts of a tape roll dispenser of the type used in warehouses for sealing boxes, etc. A few minutes of examination of one of these tools will be all that is required for the obvious attachment options to suggest themselves. They really are worth investigating, as they seem almost tailor-made for the job.

Improved Home-Built Recoilless Launchers

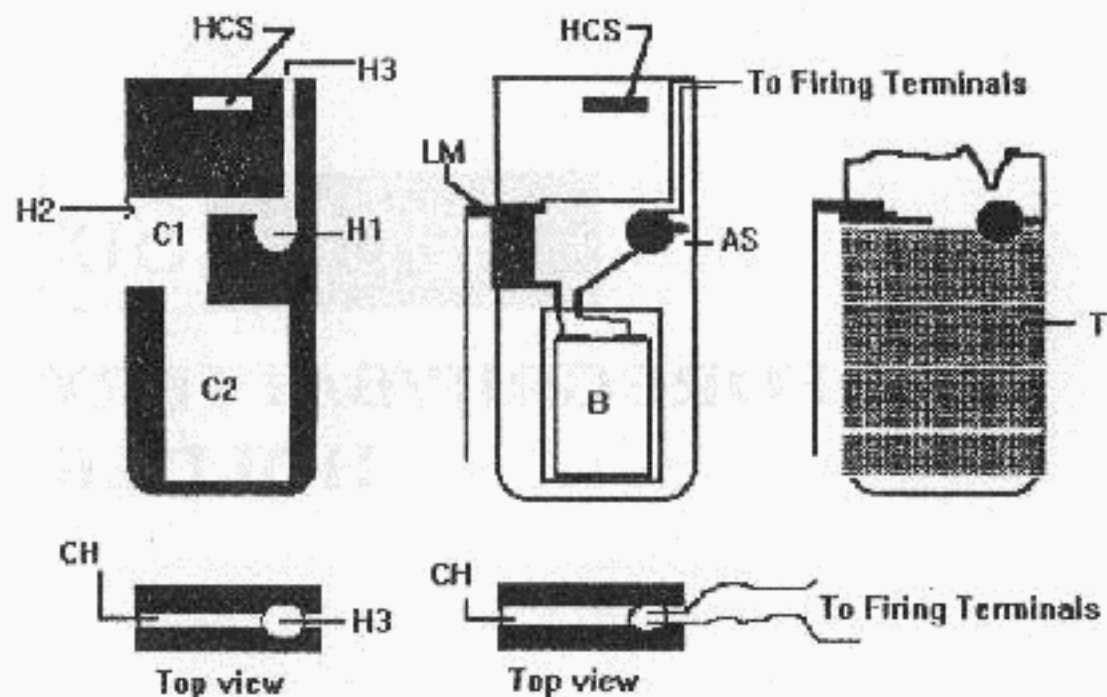

Figure 15: Foregrip/Battery Holder Construction Details.

HCS = Hose Clip Slot

H1-H3 = Holes

C1-C2 = Cutouts

LM = Long-Arm Microswitch

AS = Arming Switch

B = Battery

T = Tape

CH = Channel

Note CH cut into top of foregrip to prevent damage to interconnecting wires when foregrip is pulled up tight against the bottom of the barrel by the hose clip.

Chapter Seven

REAR SIGHT ASSEMBLY

Any number of variations are possible, including the attachment of a scope mount, but, retaining the KISS principle, a simple fixed peephole type has been employed here. Form the sight body into an L-shape and clamp the lower section to the top of the barrel with the hose clip (HC). A slot in the center of the 3-inch long vertical part of the L-shaped piece allows easy establishment of the required peephole positioning for various loads and ranges. This is accomplished by covering the slot with insulating or gaffer tape and piercing through two or three, 1/4-inch diameter holes at 3/4-inch intervals. Test-firings with the weapon aimed through each of the holes will indicate the ranges for which each hole should be marked given a particular weight of charge and warhead. Once the ranges are established, a piece of plastic or metal similarly drilled can be epoxied in place of the tape.

Chapter Eight

IGNITERS

A commercial Estes type igniter or an improvised type can be used. Perhaps the simplest improvisation is the classic cutaway bulb igniter. This is made from any small 6- to 12-volt DC bulb of the standard "globular" type or the cylindrical fuze-like type.

Solder a connecting wire to each terminal of the bulb, then carefully file away a section of the glass until access to the inside is possible. Insert enough black or smokeless powder to cover the filament, and seal the hole with masking tape.

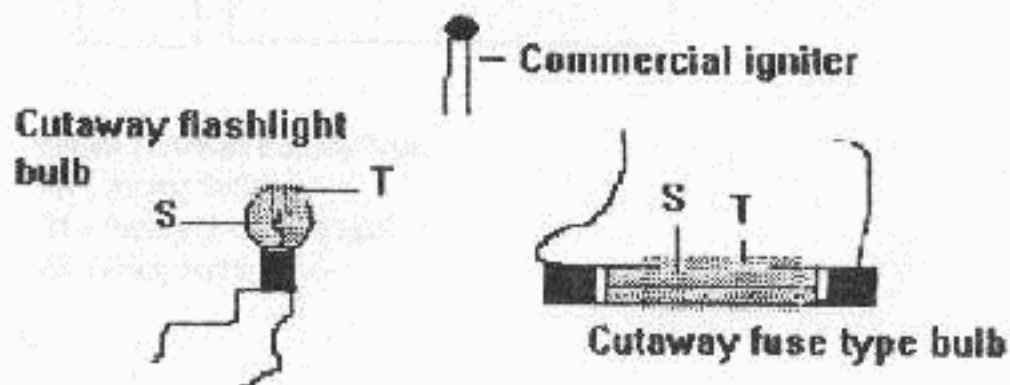

Figure 16: Commercial and Improvised Igniters.

S = Smokeless powder
T = Tape (masking tape)

Both bulb types are prepared by filing away a section of glass without harming the filament. Powder is added and the hole is sealed with masking (paper) tape. Solder on the igniter wires before installing the powder.

Chapter Nine

ARMING & FIRING CIRCUIT

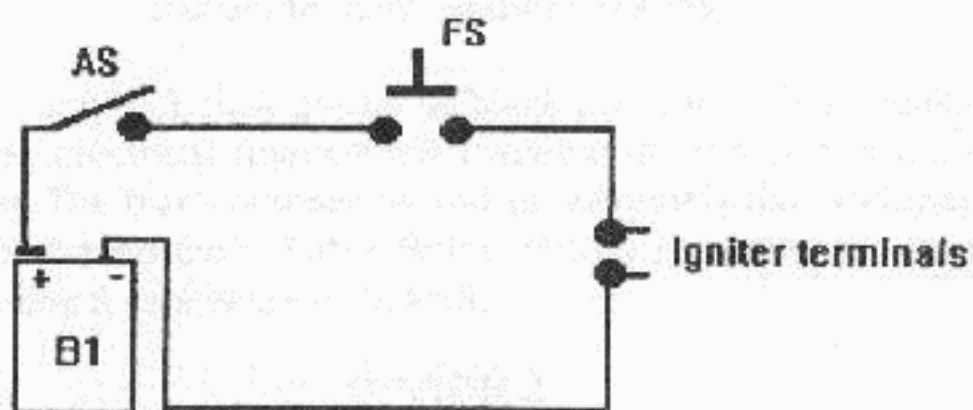

Figure 17: Direct Battery Type.

AS = Arming Switch

B1 = Battery (9-volt PP3 type)

FS = Firing Switch

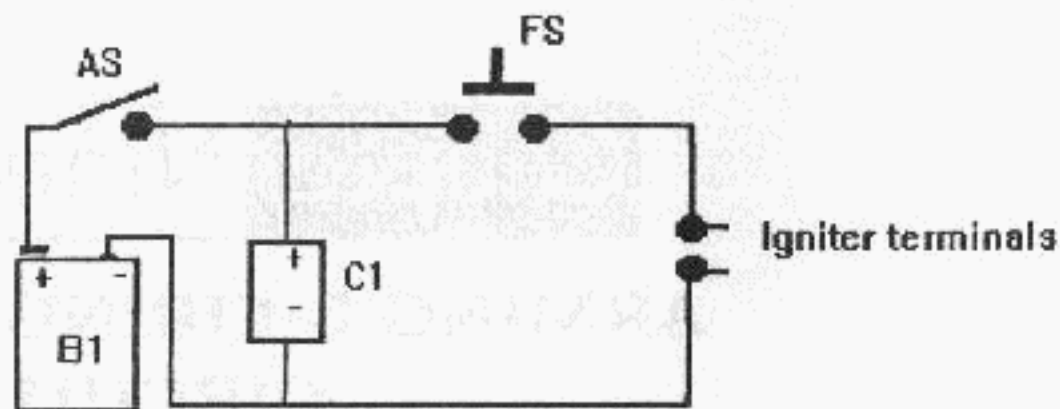

Figure 18: Battery/Capacitor Type.

AS = Arming Switch

B1 = Battery (9-volt PP3 type)

FS = Firing Switch

C1 = 10,000 mf, 12 VDC Electrolytic Capacitor (subminiature type)

Chapter Ten

CHARGE MIX DETAILS

OPTION 1

(recommended for initial testing)

Ignite 1 to 4 grams of black powder with an Estes igniter, electrical (pyrotechnic) match, or improvised bulb igniter. The black powder should be extremely fine and may be recovered from Estes flying model rocket engines if obtaining it otherwise is difficult.

OPTION 2

Ignite 1 to 4 grams of potassium perchlorate/aluminum powder mixture with an Estes or improvised igniter or electrical match. If an Estes igniter is used, add a small quantity of black powder around the igniter head as a "first-fire" material. The mixture is 7 parts by weight potassium perchlorate and 3 parts by weight fine aluminum powder tumbled until completely mixed.

WARNING: Do not attempt to prepare this mixture unless technically qualified and legally authorized to do so. Always follow applicable BATF laws and industry standard safety guidelines. Assuming you *are* technically competent *and*

Improvised Home-Built Recollless Launchers

legally authorized to manufacture the material, prepare only small quantities at a time, i.e., 10 grams maximum.

Mixing Process

Obtain any small plastic container that has a tight-fitting lid and in it place 7 grams of potassium perchlorate and 3 grams of fine aluminum powder. The aluminum powder must be the finest grade available. Fasten the lid and tumble the container continuously until the materials are thoroughly mixed. Be aware that the mixture is spark- and flame-sensitive and must be kept away from potential sources of ignition.

Chapter Eleven

CHARGE PACKETS

Once prepared, seal the propelling charge mixture in a folded piece of paper or card along with an imbedded igniter, and wrap it with a single layer of masking tape.

An alternative, more substantial container is a disassembled or used "party popper." These are small, plastic-bodied party toys that discharge a stream (actually, more usually a clump) of streamers when a "firing string" is pulled. Only the empty plastic casing is required. Use a maximum of 3 grams of potassium perchlorate/aluminum powder charge mixture. Install an igniter and 8- to 10-inch long insulated connecting wire assembly, leading the wires out through the thin rear end of the party popper body and securing them with masking tape, then add the charge powder. Seal the front of the party popper with a layer of masking tape, as shown.

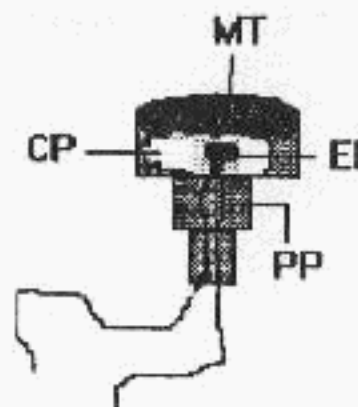

Figure 19: Party Popper Charge Packet

PP = Party Popper Body
MT = Masking Tape
EI = Electrical Igniter
CP = Charge Powder

WARNING: Do not employ a charge mix envelope, container, or alternate mixture holding system offering any more confinement to the propellant gases than that afforded by two or three layers of masking tape or thick paper. It is unnecessary and potentially dangerous unless you know *exactly* what you are doing.

Chapter Twelve

CONSTRUCTION OF WARHEAD

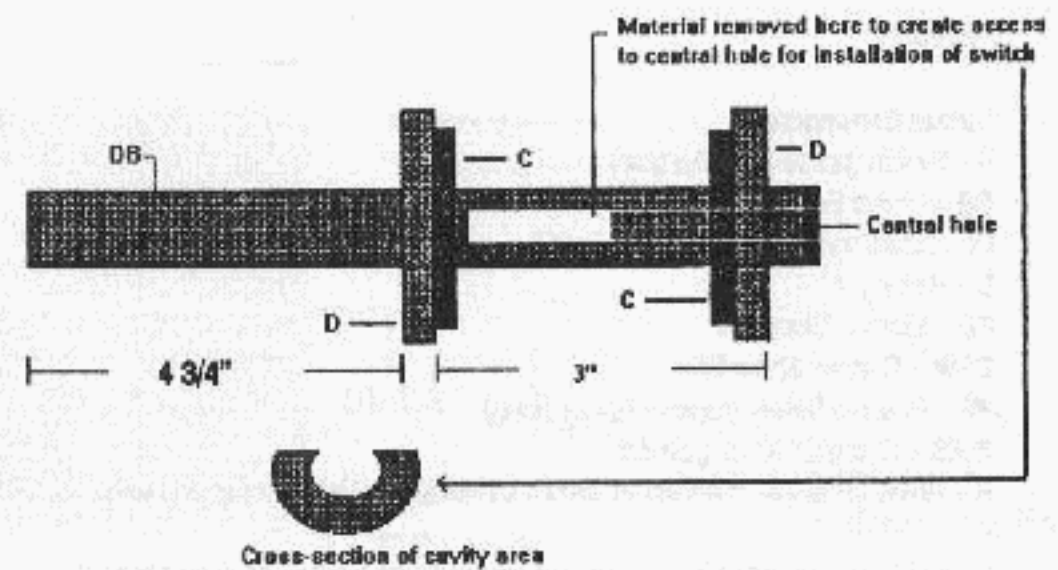

Figure 20: Wooden Warhead.

DB = Dowel Body (9-inch length, 1-inch diameter)

D = Disk (1/4-inch thick, 2 3/8-inch diameter)

C = Collar (1/4-inch thick, 2 1/4-inch diameter)

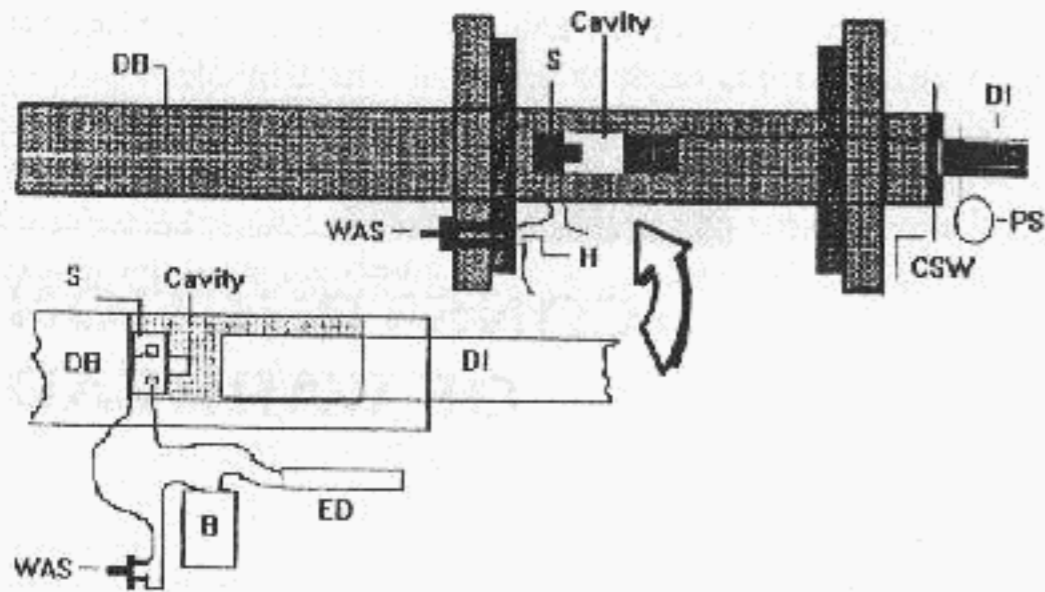

Figure 21

Circuit Schematic

- S = Switch (press-to-make type)
- DB = Dowel Body
- DI = Dowel Insert (tight sliding fit in DB)
- B = Battery
- ED = Electric Detonator
- CSW = Copper Shear Wire
- PS = Positive Safety (remove before firing)
- WAS = Warhead Arming Switch
- H = Holes (or single channel) for switch terminals and interconnecting wires

B and ED are mounted in the warhead body with an accompanying charge of explosive material.

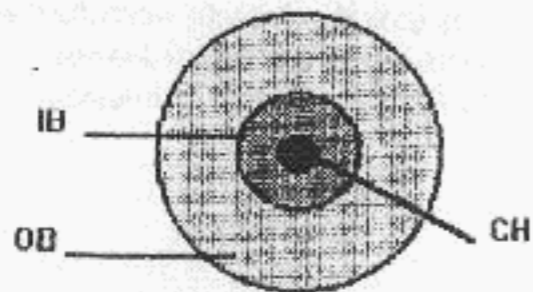

Figure 22: Front View of Warhead.

- IB = Inner (dowel) Body
- OB = Outer (cannister) Body
- CH = Central Hole

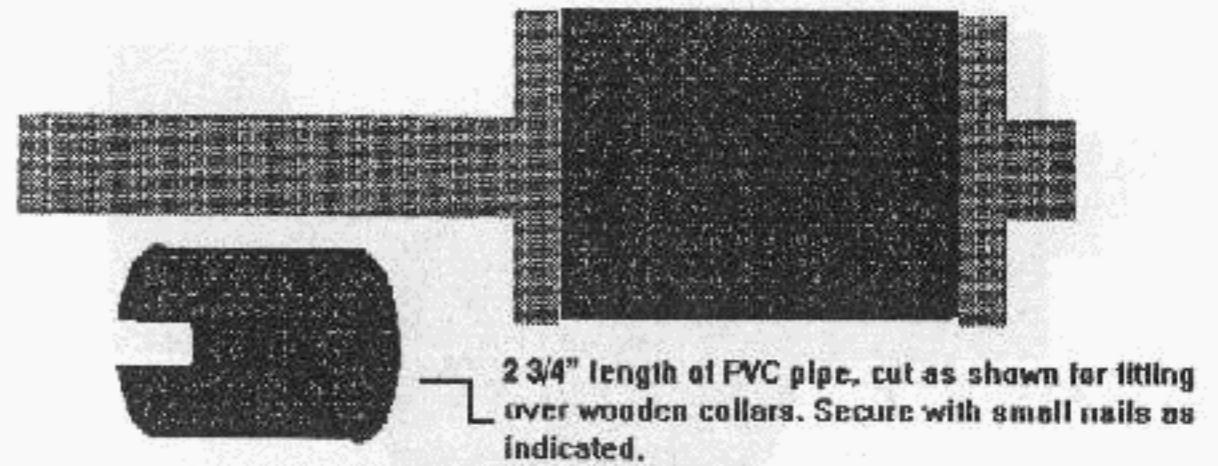

Figure 23: Wooden/Plastic Warhead Body Schematic.

- DB = Dowel Body (9-inch length, 1-inch diameter)
- INS = Insert (1/4-inch deep, 2 1/2-inch diameter)

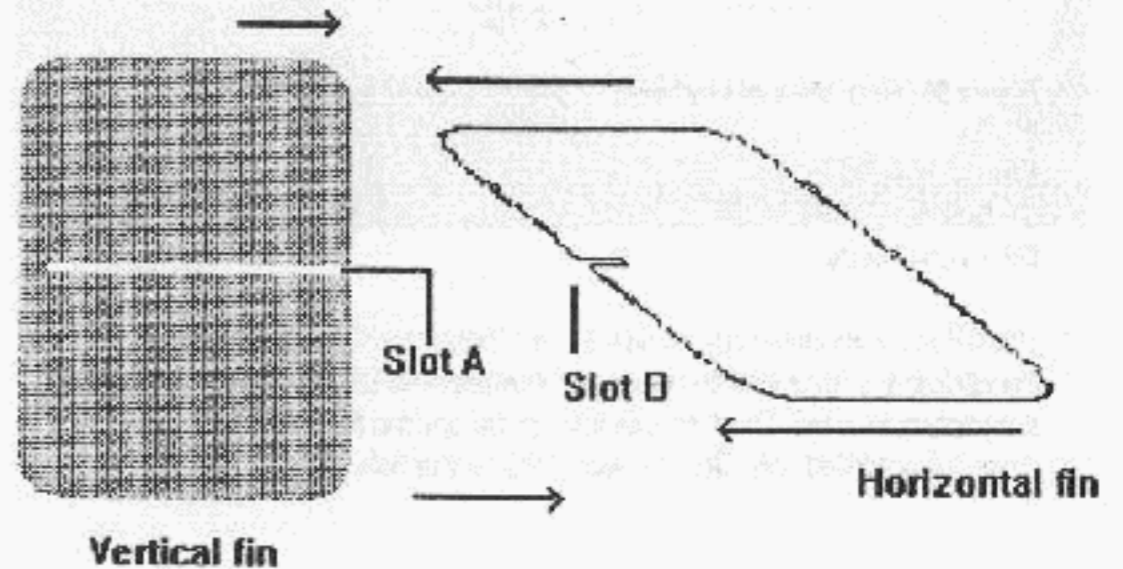

Figure 24: Fin Detail.

The fin material may be 1/16-inch to 1/8-inch-thick steel, aluminum, or plastic. Mate the vertical and horizontal fins together, as indicated, and secure them by brazing, soldering, or applying epoxy adhesive.

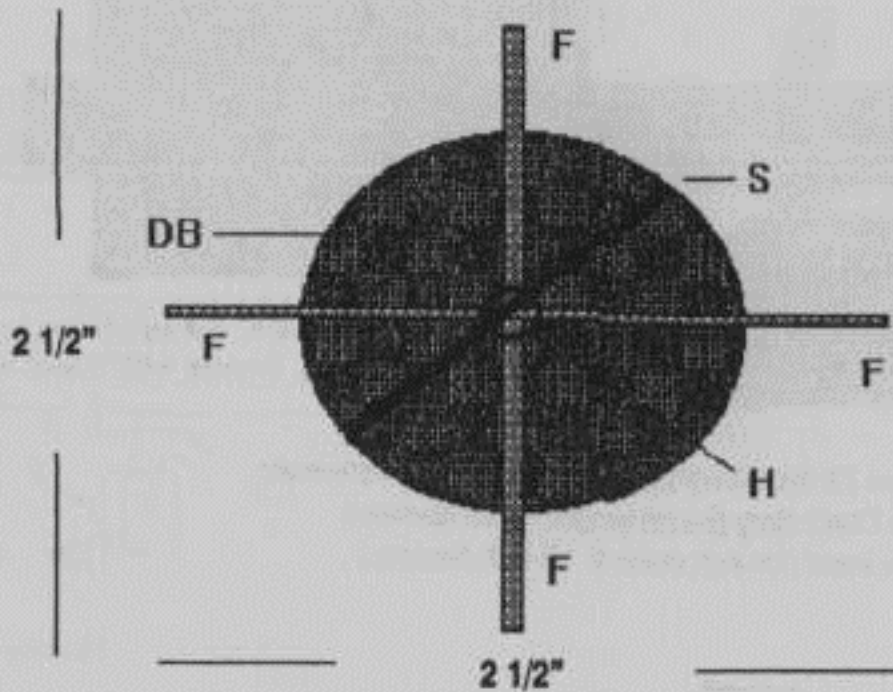

Figure 25: Rear View of Warhead.

F = Fin
 CH = Central Hole
 S = Screw
 DB = Dowel Body

The CH accommodates any uneven areas of braze or solder used to join the vertical and horizontal fin pieces and thus prevents DB from splitting when the assembly is inserted. The S passes through DB and the fin assembly through a predrilled hole. Seal the rear of the central hole with epoxy.

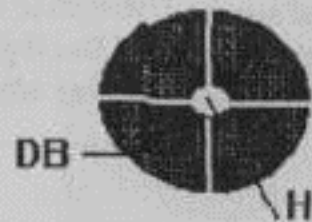

Figure 25A: Rear of DB Showing Slots and Central Hole Prior to Fin Installation.

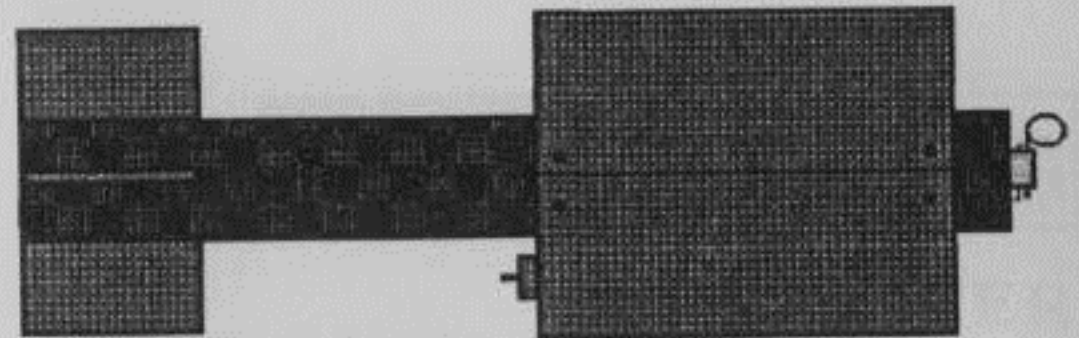

Figure 26: The Completed Warhead.

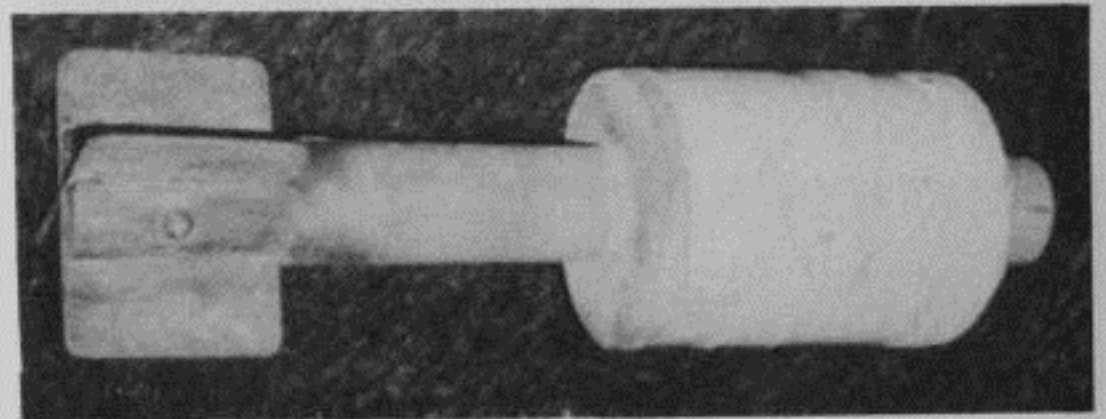

Figure 26A

Chapter Thirteen

LAUNCHER SCHEMATICS



Figure 27: Right View of Weapon.

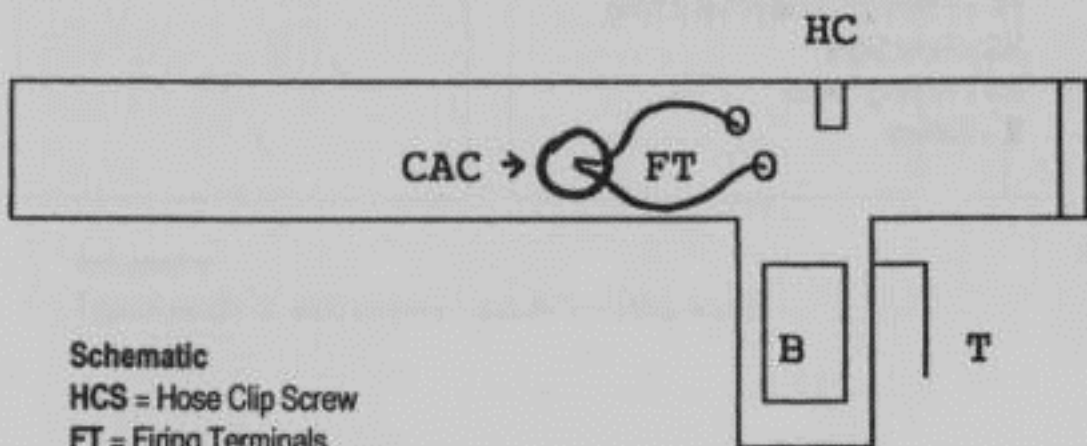

Schematic

HCS = Hose Clip Screw

FT = Firing Terminals

B = Battery

T = Trigger

CAC = Chamber Access Cover

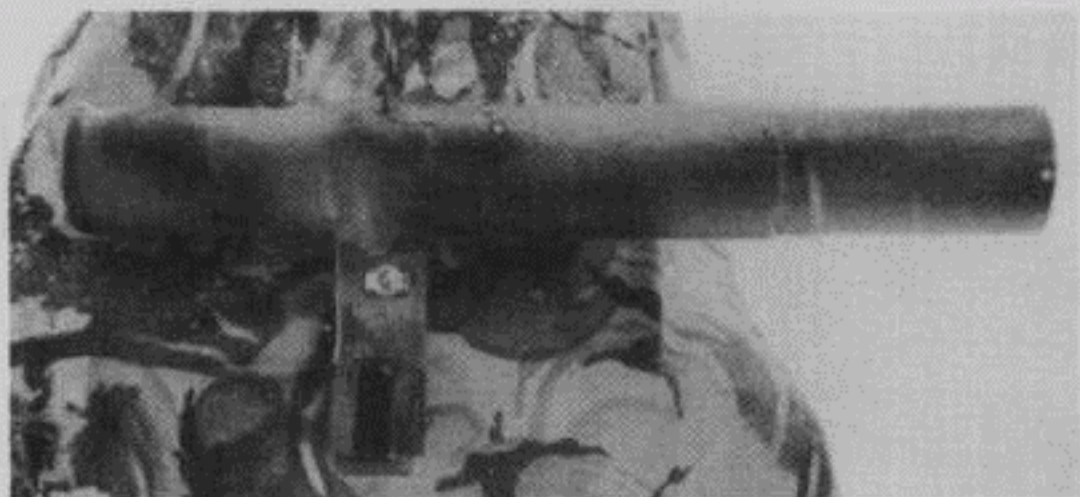
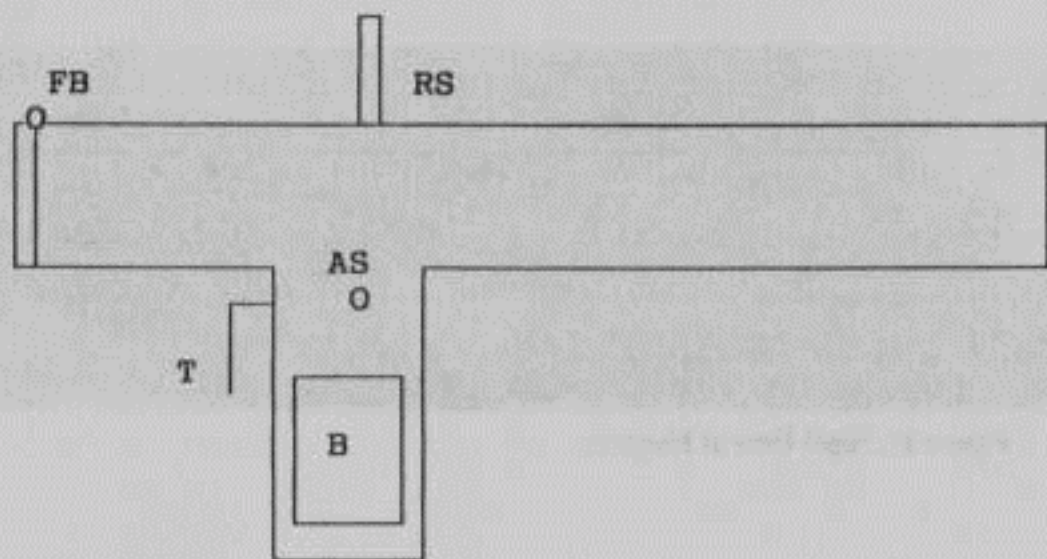

Figure 28: Left View of Weapon.



Schematic

FB = Foresight Bead (small screw)

RS = Rear Sight

AS = Arming Switch

B = Battery

Chapter Fourteen

COUNTERSHOT ASSEMBLY



Figure 29: The Countershot Assembly, Part 1: Cookies.

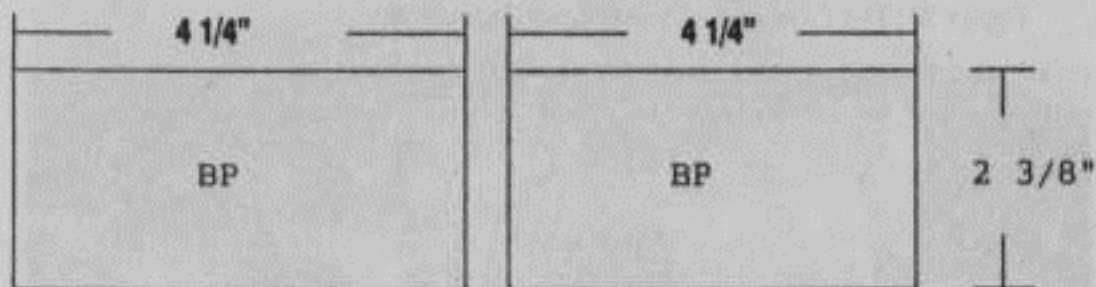

Schematic

Typical weight of each cookie packet (BP) = 5 to 8 ounces

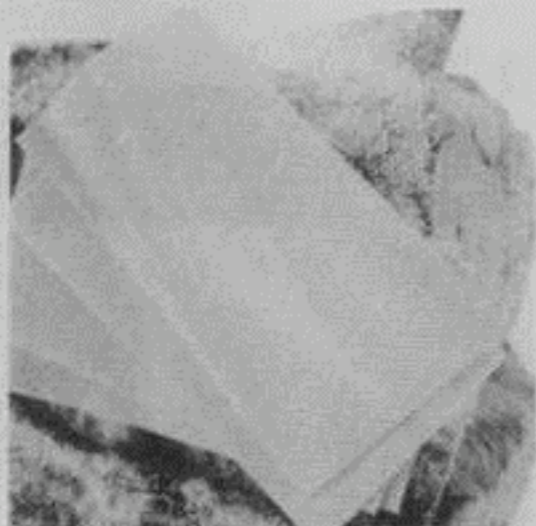

Figure 30: The Countershot Assembly, Part 2: Kitchen Cloths.

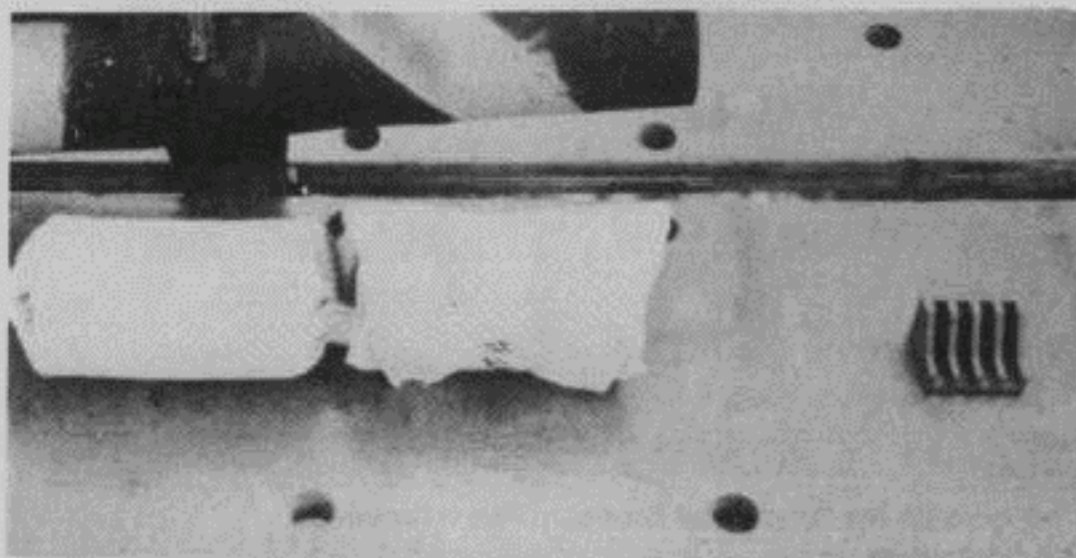

Figure 31: The Completed Countershot Assembly.



Figure 32: Loading the Countershot Assembly.

Insert the wrapped cookie packets fully into the rear of the launcher tube one at a time. Care should be taken not to damage the cookies too much. A twisting action helps, as does pressure from a piece of dowel or pipe of a diameter slightly smaller than that of the launcher tube itself.

Chapter Fifteen

TEST-FIRING

WARNING: Always use ear protection when firing this weapon.

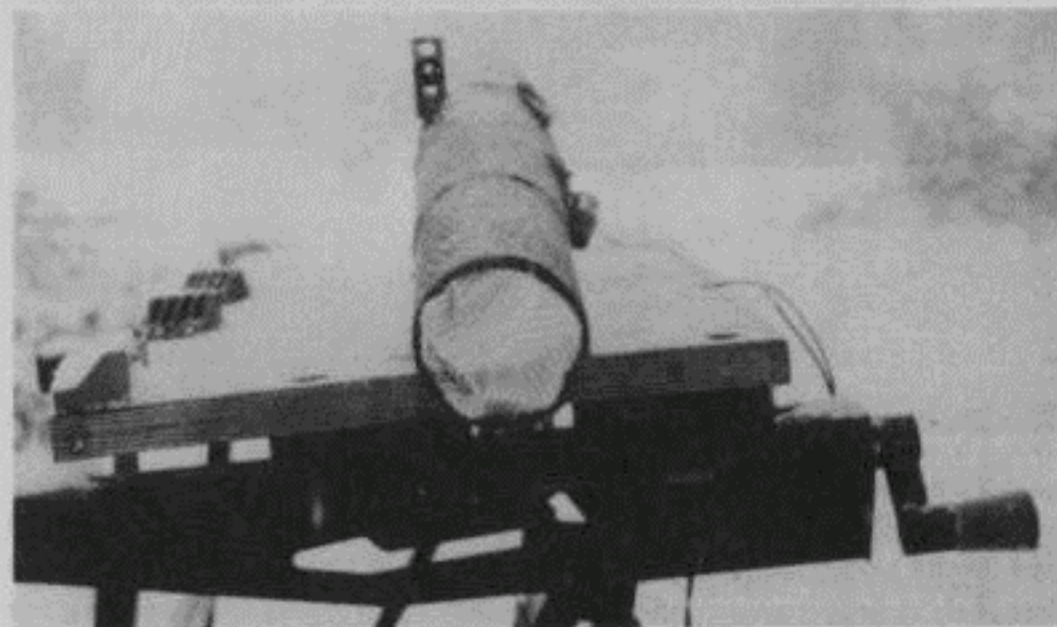

Figure 33: The Weapon Ready for Test-Firing from a Bench.

Always test-fire new designs from a bench before shoulder-firing. Here, the arming switch and trigger were bypassed and a remote battery pack was connected directly to the igniter wires. Thorough checks for cracks and failures were made after each test-fire.

Figure 34: Impact!

A successful firing, and the test warhead lands some 100 meters down range. Note the angle at which the warhead has struck. This "head-on" flight attitude is essential if impact-activated fuzes and shaped-charge designs are to work properly.

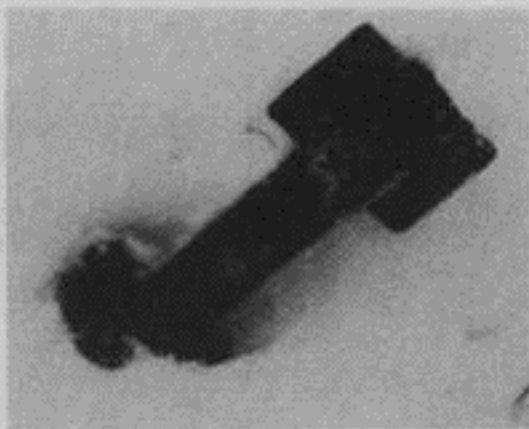

Figure 35: A "Volunteer" Poses Prior to Shoulder-Firing the Launcher.

A somewhat modified firing stance was adopted before actual firing with a view toward saving the volunteer's fingers for future use. The weapon was also successfully fired from an under-arm position. Note that in all these tests, the "maximum concealment" type of weapon was used.

Figure 36: The Backblast Area.

Immediately after firing, what seemed like the entire bird population of the area invited itself to lunch.



Intrigued by the possibilities that the successful firings of the cookie launcher suggested, the test crew looked around for alternative, unusual "countershots." About the only thing we could see at the time was snow, so we gave it a go, our reasoning being that it, like the cookies, would have a degree of "variability" in the way it would react to the explosion.

If this technique were to be replicated, it would be important to note that packing the launcher tube too tightly with snow-filled cloths would reduce (if not destroy completely) the recoilless effect. Further, on an icy day, and especially if it is snowing or raining and the launcher is getting wet, the loaded snow/cloth assemblies may freeze into the launcher tube. If this were to happen coincidentally with the warhead freezing or jamming in the tube (possibly due to repeated firings without cleaning the bore), it could spell disaster.

Figure 37: Playtime!

This picture shows a quick and dirty attempt to prove or disprove the theory. A couple of elongated "snowballs" were made and wrapped in the cloths, the same as the cookie packets. A 2 1/2 gram charge of potassium perchlorate/aluminum powder was used with the wooden warhead, and the weapon was aimed at an angle of around 10 degrees. The system worked perfectly, and the tube remained recoilless. The warhead flew flawlessly to a range of around 90 meters.



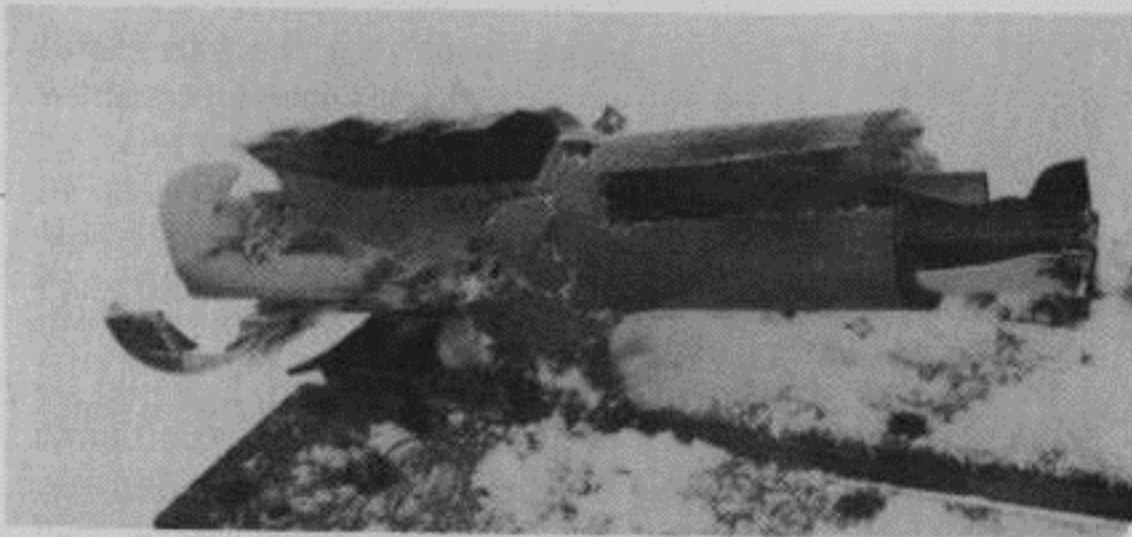

Figure 38: Disaster!

An icy day. Snow and rain. A jammed warhead. A far too powerful propelling charge, which was far too tightly confined, and an experimental "countershot" system that had frozen solid into the launcher tube. A graphic illustration of why all experimental improvised weapons systems should be tested remotely.

Appendix

CHARGE SIZE & RANGE DATA

The following tests were performed with a charge mixture of potassium perchlorate and aluminum powder installed in a used/disassembled party popper housing, the front of which was sealed with masking tape. The warhead weight was approximately 1 pound, and the weapon was fired from the shoulder at the angles of elevation shown. The ranges indicated were averaged from four firings and are well within the ranges at which the warhead will impact with sufficient force to initiate an internal firing device.

Charge Weight & Launch Angle	Range Achieved
1 gram @ 70 degrees	40 meters
2 grams @ 65 degrees	70 meters
2 grams @ 45 degrees	100 meters
3 grams @ 65 degrees	120 meters
3 grams @ 45 degrees	200 meters
3 grams @ 0 degrees	110 meters

Your search for the finest (and perhaps strangest) improvised recoilless weapon system is over. What sets this launcher design apart from the others is its unique counter-shot system, which uses cookies. Yes, cookies! What's even more amazing is that this economical and environmentally friendly system offers less felt recoil than a .22 rifle!

Other unique features include lightweight materials, a compact design, and a unique charge holder assembly that allows for rapid reloading from the outer wall of the launcher tube.

Improvised Home-Built Recoilless Launchers provides complete plans for two "cookie" launcher designs as well as step-by-step assembly instructions, detailed diagrams and schematics, photos, and test-firing data. Because the procedures described in this book and resulting end product can be dangerous, this book is offered *for academic study only*.

A PALADIN PRESS BOOK
ISBN 0-87364-830-7

Visit our Web site at www.paladin-press.com

